



THANK YOU

Congratulations on your recent purchase! We at Bowtech know that you have a choice when it comes to your archery equipment, and we want to thank you for choosing us as your hunting partner. Your feedback is important to us, as it is our desire to provide you with the absolute finest products and customer service in the industry. Please take the time to go online and register your new Bowtech bow. It is equally important to read through this owner's manual as there are valuable tips to help keep your Bowtech trouble free for many seasons.

We encourage you to contact and utilize your local dealer as they can assist you with purchases, services, and accessories. To locate the dealer nearest you, visit bowtecharchery.com and click on the "Dealer Locator" button. Frequently asked questions and additional contact information can also be found at Bowtecharchery.com.

BEFORE USING YOUR NEW BOW, READ AND UNDERSTAND THE FOLLOWING MATERIAL OUTLINED IN THIS MANUAL. FAILURE TO FOLLOW ANY OF THESE WARNINGS AND INSTRUCTIONS CAN DAMAGE THE BOW AND MAY CAUSE SERIOUS INJURY TO YOURSELF AND/OR OTHERS.

DISCLAIMER OF LIABILITY: By accepting a Bowtech product, the buyer agrees to hold harmless Bowtech and all associated parties from liability for any damage to persons or property, which may result, for any reason, from the use of this product.

QUALITY

Every Bowtech bow has undergone a comprehensive quality control process and is built from the highest quality components available. Most have been individually shot, tested and measured to ensure compliance with our strict performance standards.

CUSTOMER SERVICE

Bowtech's Customer Service will prove, not only, that our products are innovative and industry leading, but that our service is one of a kind. Do not hesitate to call us at 888-689-1289 or email at info@bowtecharchery.com if you have any questions on our products or warranty process.

LIFETIME WARRANTY

SIGN UP FOR THE LIFETIME WARRANTY AT REGISTRYOURBOW.COM

LIFETIME WARRANTY (CONT.)

All Bowtech bows come with a non-transferable lifetime warranty to the registered original owner. This warranty protects against any failures of the product due to defects in material or workmanship and does not include any damage due to abuse, misuse or modification to the bow's design. The following exclusions apply.

EXCLUSIONS

Cables and strings, bearings, paint, hydrographic film and/or other transferred finishes, accessories to include: sights, arrow rests, string silencers, quivers, or any other components included as part of an accessory package.

Damage caused by abuse, mishandling, dry-firing, alteration or modification to original product. Other excluded damages are those resulting from either loose mod screws or shooting arrows less than five grains per pound of draw weight. Damage caused by altered or damaged arrows and/or string dampening material, including original and aftermarket parts, is also excluded.

For the warranty to be enforceable, the original purchaser must complete and submit the online registration form within 30 days of purchase.

WARRANTY SERVICE

Since you are our greatest asset, we want to give you the highest quality and most efficient service possible. There are two ways you can request warranty repairs for your Bowtech products.

Option 1: Contact our Customer Service Team at 888-689-1289 to work directly with a representative that will help you determine the best way to repair your product.

Option 2: Contact your nearest authorized dealer for your warranty repair. They will facilitate the inspection and diagnosis of any problem.

In the event that a bow must be returned for factory service, a Return Merchandise Authorization (RMA) number must first be obtained for your return product. Bows returned to the factory without an RMA number will not be accepted. Bowtech will not be held responsible for any lost product without proper documentation of an RMA number.

The bow owner is responsible for the return prepaid freight to Bowtech. No COD shipment will be accepted. Bowtech will perform the warranty service required and return the product to the dealer prepaid.

- All methods of shipping by UPS or FED-EX only. Sender should insure all shipments.
- If your bow cannot be repaired, we reserve the right to replace your bow with a newer model of greater or current market value.
- Bowtech reserves the right to substitute any parts required for warranty coverage at its sole discretion.

TUNING AND PROPER FIT

It is very important that your bow is adjusted to fit you properly. Assistance in achieving proper fit should be provided by your Authorized Bowtech Dealer.

The draw length of all current Bowtech bows can be adjusted without draw length specific modules. The Rotating Mod System makes this feature possible. By simply rotating the module clockwise or counterclockwise, your draw length can be adjusted in 1/2 inch increments. The Bowtech CP28 comes equipped with a FlipDisc for its rotating module system.

CHANGING DRAW LENGTH

Refer to Figure 1 & 2 and Chart 1

1. You will need to press your bow, in some settings, to adjust the draw length on bows with the DeadLock Cam System. Bowtech recommends that you only use a limb tip press to service your bow and that you take your bow to your Authorized Bowtech Dealer for adjustment of your bow's draw length.

2. Once the bow is in the press and the tension on the string and cables has been relieved, use a 7/64 inch hex wrench to remove the FlipDisc screws that attach the FlipDiscs to the cams.

3. Notice the numbers on the cam and the reference pin on the FlipDisc. The numbered marks corresponds to the draw length setting.

4. To adjust the draw length, rotate the FlipDisc so that the pin on the FlipDisc lines up with the number on the cam.

5. Replace the three FlipDisc screws on each cam and retighten. **We recommend applying blue Loctite 242 to the threads before replacing them at your desired setting.** This will prevent the screws from loosening during normal use of the bow.

6. Ensure all strings and cables are in their appropriate grooves and remove the bow from the press.

7. After repositioning the FlipDisc, you will need to reposition the draw stop post. To do this, use a 3/32 inch hex wrench to remove the post from its current position.

8. Screw the post into the hole that matches (in most cases) the numbered slot that you placed the FlipDisc indexing pin in. For example, if the FlipDisc was placed in the 29" position, the draw stop post should also be placed in the 29" position. Refer to Chart 1 for post settings.

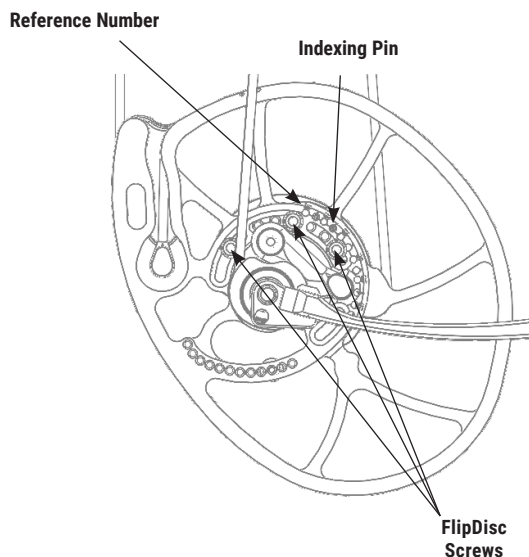

Figure 1: CP28 Series FlipDisc Settings

FlipDisc Position	CP28	
	Draw Length	Post Setting
30	30	30
29.5	29.5	29.5
29	29	29
28.5	28.5	28.5
28	28	28
27.5	27.5	27.5
27	27	27
26.5	26.5	26.5
26	26	26
25.5	25.5	25.5
25	25	25
24.5	24.5	24.5

Chart 1: CP28 FlipDisc & Post Settings

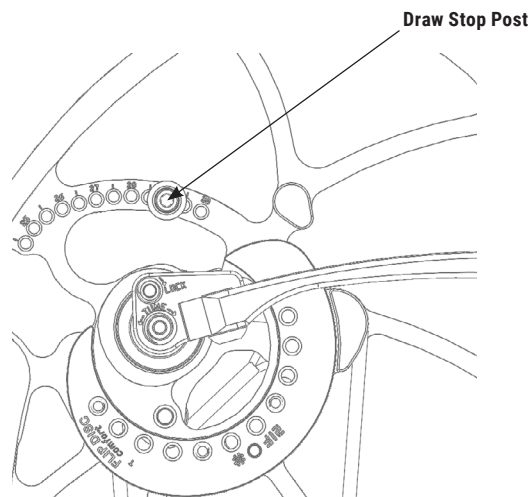

Figure 2: CP28 FlipDisc & Post Settings

ADJUSTING THE FLIPDISC™

Refer to Figure 3

Your new Bowtech bow features FlipDisc™ Technology. You can easily adjust the FlipDisc to your desired setting by following these simple instructions.

1. Bowtech recommends that you finalize all draw length adjustments prior to adjusting the FlipDisc setting. Use a hex wrench to remove all FlipDisc screws completely.
2. Flip the disc to your desired side. One side of your FlipDisc is labeled "Performance" and the other is labeled "Comfort". To utilize the Performance setting, set the FlipDisc so that the word "Performance" is visible. To utilize the Comfort setting, flip the FlipDisc so the word "Comfort" is visible.
3. Replace the FlipDisc screws with the FlipDisc in the desired draw length position and secure.
4. It is recommended that all FlipDisc screws are torqued between 22 and 25 in-lbs in conjunction with Blue Loctite 242 once the desired setting has been determined. Ensure that both Discs are set to the same setting before drawing your bow.

Caution - Bowtech strongly recommends the use of blue removable Loctite on all FlipDisc screws on cams featuring PowerShift™ Technology.

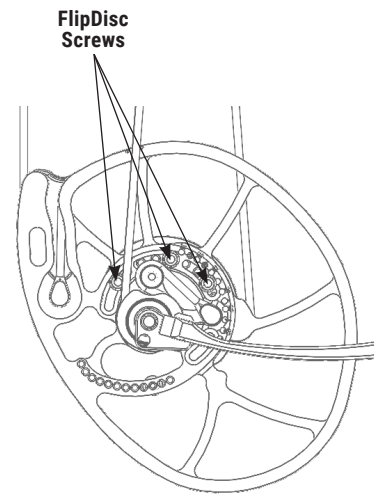

Figure 3: FlipDisc Adjustment

ADJUSTING THE STRING POSITION WITH THE DEADLOCK CAMS

Your new CP28 bow features the DeadLock Cam System with the unique ability to fine tune the string path quickly and easily for optimal accuracy. With any adjustments to your Bowtech bow, it is highly recommended you visit your local dealer. Fine tuning of the string path can be accomplished by utilizing the DeadLock Cam System Tuning Screw.

To adjust the DeadLock cam system (see Figure 4):

For right-handed bows:

1. Loosen by turning the Tuning Lock Screw to the left (counterclockwise) using a 3/32 hex wrench.
2. To move the cam to the left, turn the Tuning Screw to the right (clockwise) using the same 3/32 hex wrench.
3. To move the cam to the right, turn the Tuning Screw to the left (counterclockwise).
4. Once the desired position is set, lock the DeadLock Cam system by turning and hand tightening the Tuning Lock Screw to the right.

For left-handed bows:

1. Loosen by turning the Tuning Lock Screw to the left (counterclockwise) using a 3/32 hex wrench.
2. To move the cam to the left, turn the Tuning Screw to the left (counterclockwise) using the same 3/32 hex wrench.
3. To move the cam to the right, turn the Tuning Screw to the right (clockwise).
4. Once the desired position is set, lock the DeadLock Cam system by turning and hand tightening the Tuning Lock Screw to the right.

To reset the cams to zero:

For right-handed bows:

1. Loosen by turning the Tuning Lock Screw to the left using a 3/32 hex wrench.
2. Turn the Tuning Screw to the left (counterclockwise) until the cam stops on the right side. Repeat this step for both top and bottom cams.
3. Turn the Tuning Screw two full rotations to the right (clockwise). This will set your cams at zero and assure they are lined up on the axes.
4. Repeat this step for both top and bottom.

For left-handed bows:

1. Loosen by turning the Tuning Lock Screw to the left using a 3/32 hex wrench.
2. Turn the Tuning Screw to the left (counterclockwise) until the cam stops on the left side. Repeat this step for both top and bottom cams.
3. Turn the Tuning Screw two full rotations to the right (clockwise). This will set your cams at zero and assure they are lined up on the axes.
4. Repeat this step for both top and bottom.

Ensure both the top and bottom cams are moved equally when making adjustments.

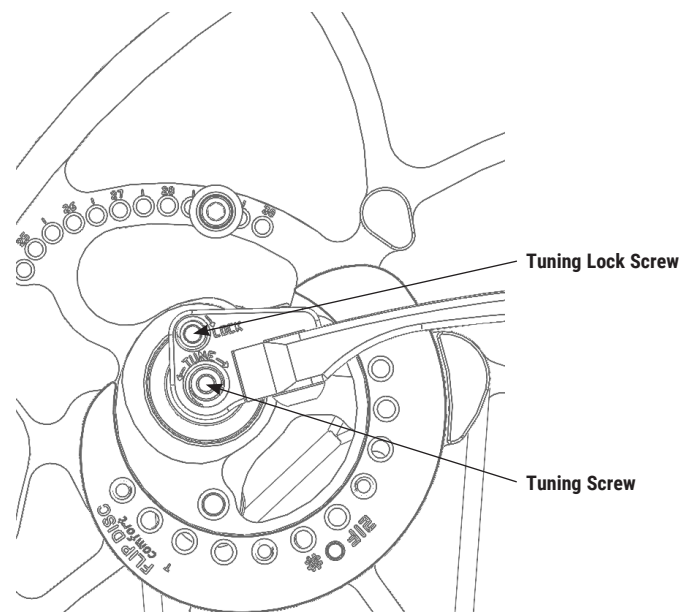

Figure 4: DeadLock Adjustment

SETTING THE DRAW WEIGHT

Consult your local Authorized Bowtech Dealer for information regarding weight adjustment for your bow model. All bows perform best at peak weight.

Draw weight can be adjusted by using a hex wrench to either tighten or loosen the limb bolt. The specific method for adjusting draw weight varies by model as described below.

WARNING: DO NOT TURN THE LIMB BOLTS OUT MORE THAN THE RECOMMENDED AMOUNT. Doing so could cause the limbs to break out of their pockets and result in bodily injury.

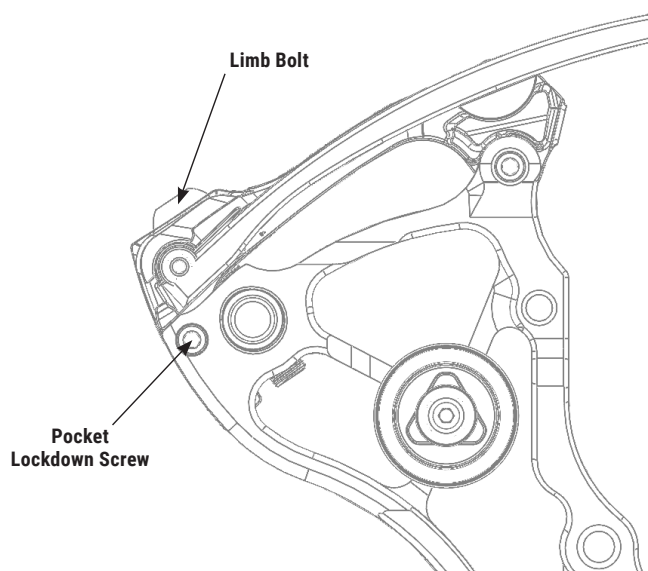

Figure 6: Draw Weight Adjustment

Draw weight on the CP28 can be adjusted 10 pounds down from the bow's peak draw weight. For example, if the bow is shipped as a 60 pound model, the draw weight can be adjusted down to 50 pounds. The procedure is as follows (**see figure 6**):

Loosen the Pocket Lockdown Screw, using a 5/32 inch hex wrench. Using a 7/32 inch hex wrench, tighten or loosen the limb bolt to increase or decrease draw weight. One full turn equals approximately 1 pound. DO NOT back out the limb bolt beyond the pocket lockdown screw. The top and bottom limb bolts should be tightened and loosened equally. Re-tighten the Pocket Lockdown Screw with the 5/32 inch hex wrench.

ADJUSTING THE STRING STOP

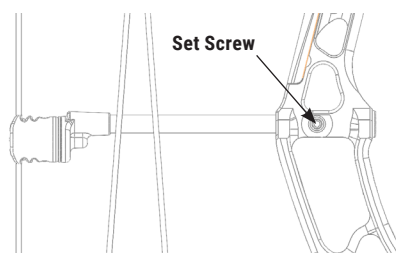

Figure 5: Adjusting the string stop

To increase the effectiveness of your string stop dampener you want it to maintain contact with the string at rest. If you have backed down the draw weight to set your draw to your comfort level you may need to adjust your string stop as your brace height may have increased. To do this, loosen the side set screw on the riser as shown (**Figure 5**) with a 1/8 hex wrench. Pull out the string stop until it makes contact again with the string. Verify that the string stop is oriented correctly and retighten the side set screw.

SETTING CENTER SHOT

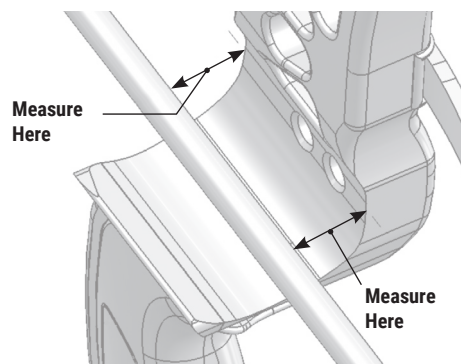

Figure 7: Determining Center Shot

Center shot can be set by measuring from the back of the riser to the arrow and then from the front of the riser to the arrow. Once this is equal, you are at the approximate center shot of your bow (**see Figure 7**). This is a good starting point when tuning your Bowtech bow. Keep in mind, not all bows tune at exact center shot due to the variances in arrow spine, hand position, and your specific bow poundage. Adjust your arrow rest until the two measurements are equal.

TIMING THE CAMS

There are small indentations or "timing dots" on the cam near its perimeter. When viewing the bow directly from the side opposite the module, the cable should be approximately centered in between the timing dots as shown in **Figure 8**. Adjusting the timing requires that the bow be put in a press, and as such, your Authorized Bowtech Dealer should perform all timing adjustments.

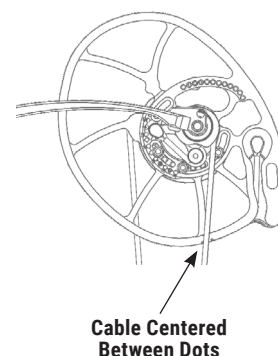

Figure 8: Cam Timing

BOW MAINTENANCE

Your Bowtech bow was made with the highest quality components to last for a lifetime of use in the field with proper maintenance. It is important that you **NEVER** draw and release a bow without an arrow on the string. This could not only hurt you, but can damage your bow. If the bow is dry fired at any time, take it to your local dealer for a complete inspection. **NEVER** leave your Bowtech bow in an area of extreme temperatures. This could cause your string and cables to stretch, which effects timing.

Before shooting your bow, **ALWAYS** inspect the string and cables and check the limbs for any visible damage. If damage is found, take the bow to your local Bowtech dealer for inspection or repair.

Your Bowtech bow comes equipped with sealed bearings in both cams. There is no need to lubricate cams.

Your Bowtech bowstring is manufactured to provide long string life and absolute consistency, shot after shot. This results in greater

GENERAL INFORMATION

Your new Bowtech bow is a highly tuned, precise shooting machine. It requires special care and handling to achieve and maintain peak performance. The string, cables and limbs are under extreme tension, which creates an incredible source of energy that must not be taken for granted. Please respect this power and use it properly.

Bowtech bows are standardized to fit most manufacturers' accessories and will perform best when shot with a release.

ADULT SUPERVISION OF ALL CHILDREN UNDER THE AGE OF 18 IS REQUIRED. Bowtech has designed your bow to be a safe and fun product. However, as with any shooting style product, safety rules must be observed. It is HIGHLY recommended that these rules be read before using any bow.

Bows and arrows are NOT toys. For maximum safety and enjoyment, always exercise caution and common sense when shooting any bow.

WARNING: NEVER DRY FIRE THE BOW

NEVER draw a bow without an arrow nocked. Doing so could cause personal injury and/or damage the bow. When drawing a bow for inspection or demonstration, never release the string at full draw to let down. Hold onto the string and do not let it slip out of your hands. Without the resistance of a properly weighted arrow to absorb the energy, you may damage the bow and cause personal injury to yourself and/or others.

ALWAYS wear safety glasses when operating or adjusting your bow.

ALWAYS use an appropriate backstop for maximum safety. An appropriate backstop must be constructed of a durable material and must extend beyond the perimeter of the target. The recommended backstop size is determined by the accuracy and ability of the shooter. With a low level of shooter accuracy, the backstop perimeter requirement must be increased appropriately.

NEVER aim or draw any bow in the direction of a person. Aim and draw ONLY in the direction of an appropriate target. **ALWAYS** have a full view of the path to and beyond the target when shooting.

We encourage you to contact and utilize your local dealer as they can assist you with setting up your bow, tuning, purchases, services and accessories. To locate the dealer nearest you, visit bowtecharchery.com and click on the "Dealer Locator" button. Frequently asked questions and additional contact information can also be found at bowtecharchery.com.

STRINGS & CABLES

accuracy and less time spent re-tuning your equipment.

It is recommended that you cycle the bow 10-20 times to settle the string as a result of relaxation during packaging and shipping.

Wax the string often. We recommend BCYML 6 synthetic string wax or an equivalent product. To wax the string, apply wax liberally to entire length of string. Rub briskly with fingers until the string appears slick. Remove all excess wax with a clean cloth. We recommend that you wax every other time you shoot your bow to lengthen the life of your string and cable sets.

ALWAYS check all arrow components prior to shooting, including nock, insert and tip. Loose components can cause unbalanced arrow flight and partial dry firing of the bow. If an arrow has been damaged, or if you believe it has been damaged, do not shoot it again, as it could break on release, and sharp arrow pieces could strike and injure you or someone nearby.

NEVER retrieve arrows or allow anyone else to do so until all arrows have been shot.

NEVER draw the bow without properly adjusted limb bolts (see "Adjusting Draw Weight" section for more information). Make sure the string and cables are properly attached to the correct post and in the correct tracks in order to avoid possible injury.

DO NOT attach anything to the cables or string that could create excessive wear or slice the string material. This will void the warranty.

DO NOT cross cables in any configuration other than the configuration set by the factory. This will have an adverse effect on the performance and shootability of your bow. Further, it may cause extreme wear to the string, cable, and cable-slide/roller guard.

Any alteration from the factory specifications or the adjustments outlined herein will void the factory warranty. ALL maintenance must be performed at an Authorized Bowtech Dealer.